

Multiline Seal in V100S 0.2
Modul: 0.2
(RSK-nummer: 291 92 85)

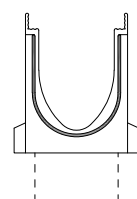

Multiline Seal in V100S 5.2
Modul: 5.2
(RSK-nummer: 291 92 86)

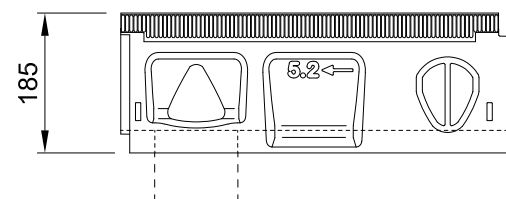
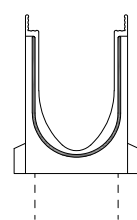
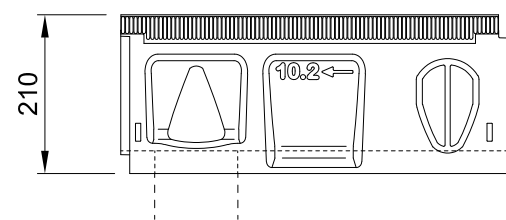

Multiline Seal in V100S 10.2
Modul: 10.2
(RSK-nummer: 291 92 87)

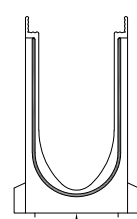
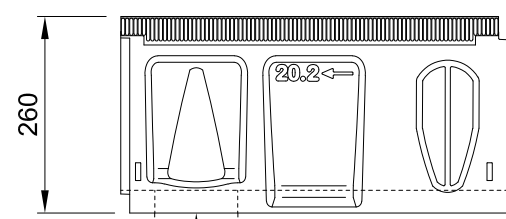

Multiline Seal in V100S 20.2
Modul: 20.2
(RSK-nummer: 291 92 88)

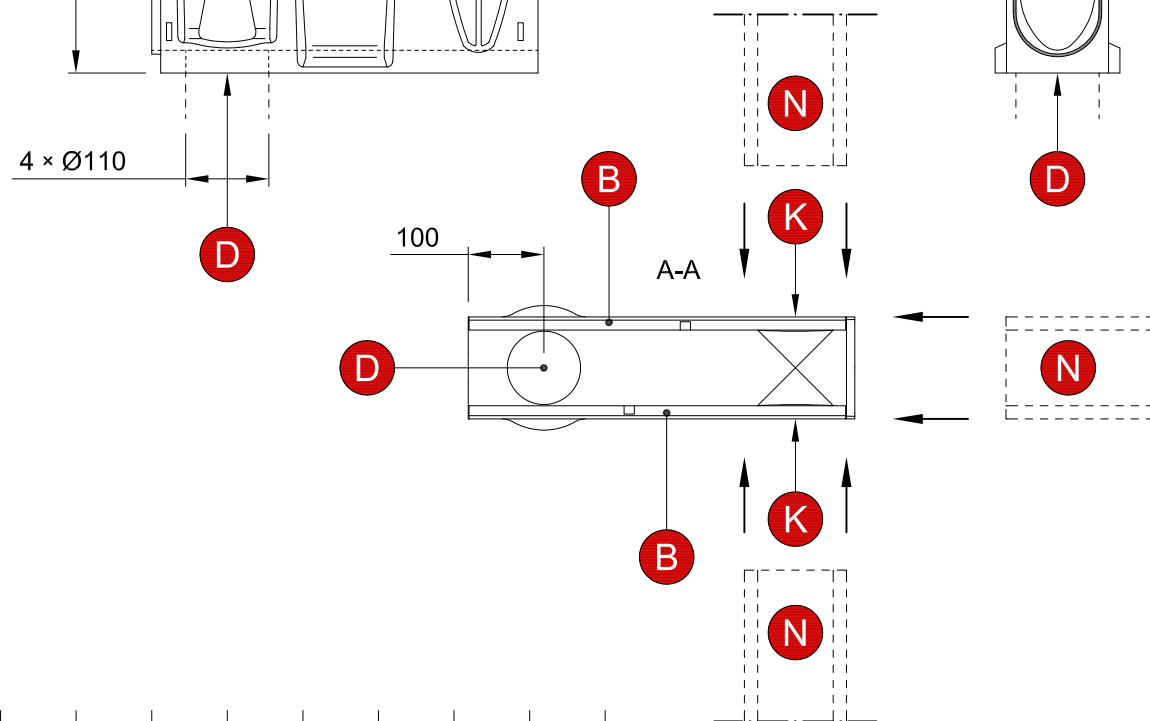

Millimeter

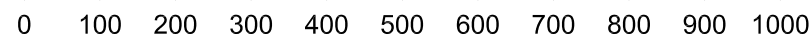

Förklaringar

Alla mått i millimeter
Dimensioner avrundade till närmsta hela mm
om ej annat anges

- A Integrerad gummitätning
- B Integrerad kantförstärkning
- C V-format tvärsnitt
- D Bottenutlopp
- K Möjlig anslutning
- N Anslutande ränna

888* Dimension avrundad till närmsta hela 5 mm

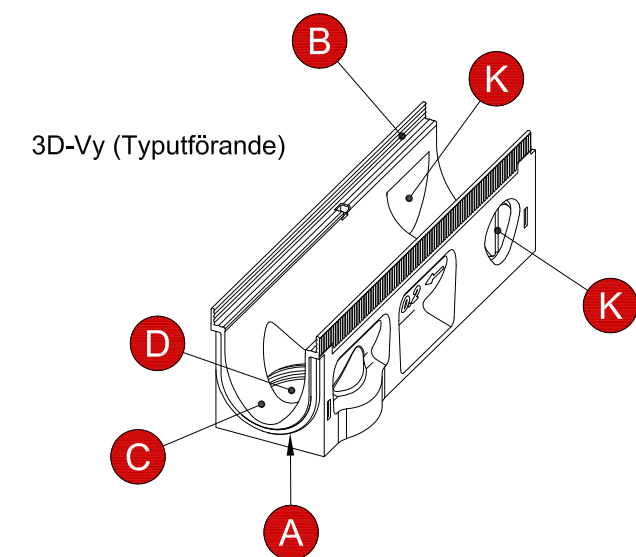

Egenskaper

Material	Polymerbetong
Rännbredd	100 mm
Kantförstärkning	Varmförzinkat stål
Belastningsklass	A15 - E600



ACO Nordic AB
Industrivägen 4
433 61 Sävedalen
www.aco-nordic.se

Produkt

Multiline Seal in V100S
Ränna utan fall, Bottenutlopp - 500 mm

Skala
1:10 (A3)

Ritning
2D